

Marconi's Wireless Telegraph Company, Limited

MARCONI HOUSE, STRAND, LONDON, W.C.

Telegraphic Address: 'EXPANSE, WIRE, LONDON.'

Telephone No. 8710, CITY (Ten Lines)

INDEX.

PAGE	INSTRUMENT.	PAGE	INSTRUMENT.
4 ..	Marconi's Magnetic Detector.	30 ..	Short Wave Portable Crystal Set.
6 ..	Portable ,, Receiver.	32 ..	Marconi Direction Finder.
8 ..	Multiple Tuner (long).	33 ..	,, ,, ,,
10 ..	,, ,, (short).	34 ..	Wavemeters, No. 1.
12 ..	Valve Receiver, No. 1 (short waves).		,, No. 2.
	Valve Receiver, No. 2 (intermediate waves).	36 ..	Decremeter, No. 1.
			,, No. 2.
14 ..	Valve Receiver, No. 1) Long waves.	38 ..	,, No. 3.
	,, ,, No. 2)		,, No. 4.
16 ..	Universal Crystal Receiver.	40 ..	Tuning Inductances and Condensers.
18 ..	Balanced Crystal Receiver (short waves).	41 ..	Variable Condensers.
20 ..	Balanced Crystal Receiver (short waves).	42 ..	Fixed Telephone Condensers.
22 ..	Balanced Crystal Receiver (long waves).	43 ..	Telephone Transformers.
24 ..	News Reception Receiver, No. 1.	44 ..	Valves and Crystals.
26 ..	,, ,, ,, No. 2.	45 ..	Resistances, Crystal Clips.
28 ..	Demonstration Set.	46 ..	Charging Boards.
			Battery Boxes. Buzzers.

In referring to Instruments please give Reference Number and wave range required. Some of the Instruments in this list are supplied in travelling cases, to prevent damage to the polished wood, etc., during storage and packing. The travelling case, it should be noted, is not sufficient packing for transportation by railroad.

Marconi's Magnetic Detector.

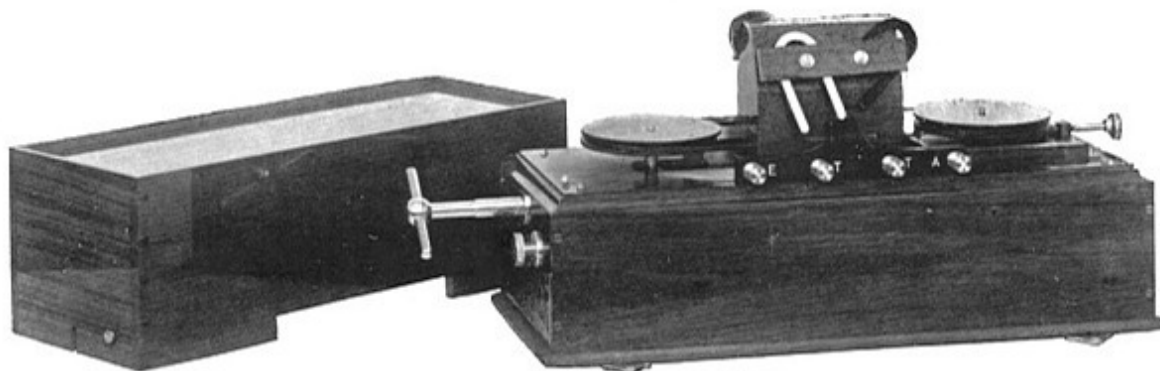

Reference No. 101 R. Code Word: *Aflash.*

Patent No. 10245/1902.

One Case.

Overall Dimensions $22\frac{1}{2} \times 8\frac{1}{2} \times 10\frac{1}{2}$ inches.

Weight 19 lbs.

Wave Range.—Limited only by the tuning arrangements supplied with the Detector.

Can be fixed in any position suitable for easy handling of winding gear.

Clockwork runs noiselessly for 90 minutes without rewinding.

Telephones Required.—Low resistance (Ref. No. 128 R).

A spare iron band with primary and secondary coils is supplied.

The Detector should be used in connection with

Tuner No. 1 (Ref. No. 103 R),
or Tuner No. 2 (Ref. No. 104 R);

or in special cases can be used in connection with

Valve Receiver (Ref. No. 106 R),
Crystal Receiver (Ref. No. 108 R),
Crystal Receiver (Ref. No. 110 R);

or with the Combined Condenser and Aerial Tuning Inductance (Ref. No. 124 R).

Marconi's Magnetic Detector—(Continued).

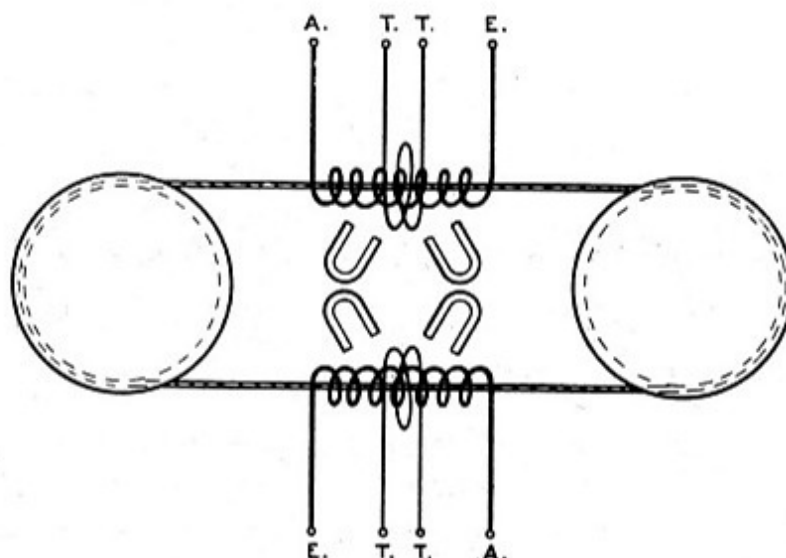

Diagrammatic View of Marconi's Magnetic Detector.

The Instrument consists of a band of insulated iron wires moving through duplicate sets of coils in front of a system of permanent magnets. As a general thing only one set of coils is in use at once, but with extremely long waves the two sets can be connected up, primaries in series and secondaries in series, with enhanced effect.

There are no adjustments on this Detector for the operator to make. It is sent out from the factory adjusted to maximum sensitiveness and will retain this sensitiveness indefinitely.

This Detector is suitable for all cases where absolute certainty of communication is desirable and where no one specially skilled in adjustment is obtainable.

Where Detectors of great sensitiveness, such as crystals, are used, and the skilled operators are relieved during certain hours by less skilled assistants or boys, a Magnetic Detector should always be installed.

Marconi Portable Magnetic Receiver.

(Suitable for Time Signals and Weather Reports.)

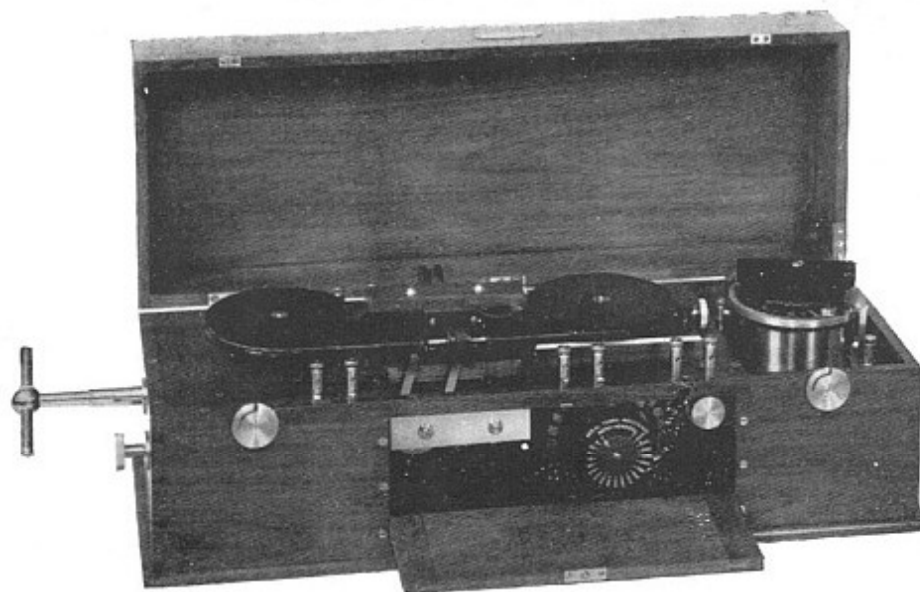

Reference No. 102 R. Code Word: *Arrovatron.*

Patents Nos. 11575/1897, 15909/1906, 10245/1902. Special Pamphlet on application.

One Case.

Overall Dimensions $22\frac{1}{2} \times 8\frac{1}{4} \times 7\frac{3}{8}$ inches.

Weight 24 lbs.

Wave Range.—Determined by aerial in use;
on average ship aerial, 300–3,000 metres.

Suitable for fixing in any convenient position, preferably arranged so that the winding key can easily be handled.

The Receiver is supplied complete with a pair of low resistance telephones which pack into the front of the case.

A spare iron band with primary and secondary coils is usually supplied.

Marconi Portable Magnetic Receiver—(Continued).

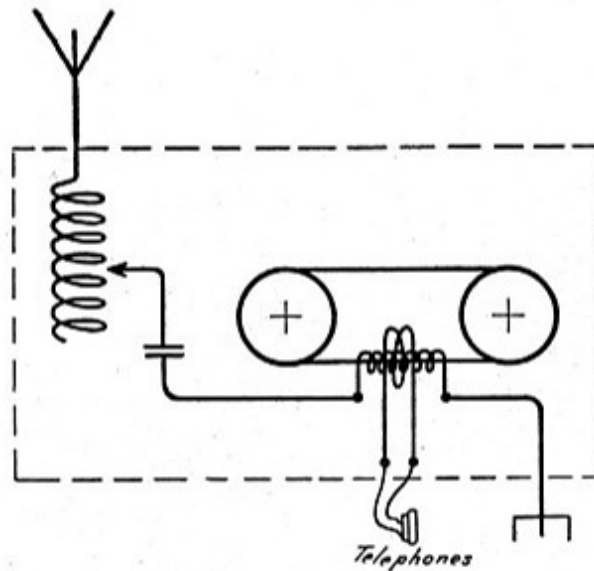

Diagrammatic View of Connections of Receiver.

This Receiver consists of a Marconi Magnetic Detector, aerial tuning inductance and condenser combined in a portable form.

The Magnetic Detector can easily be adapted to any circuit by the simple alteration of the primary winding of the Detector.

A standard winding has been determined which is well adapted for direct insertion in series with the aerial wire, earth, and the tuning inductance and condenser. Only one adjustment in the whole instrument has then to be made to cover a very large range of wave length.

After the connection of the aerial earth and telephones to the terminals of the Receiver and the iron band has been set in motion, for short waves the variable condenser and zero inductance give all the necessary adjustment, and for long waves the condenser at 'short' and the variable aerial tuning inductance gives all the necessary adjustment for wave lengths up to a length only limited by the size of the aerial.

The Marconi Portable Magnetic Receiver is the simplest and most reliable complete wireless receiver in existence, and it is difficult to conceive of anything simpler or more certain in its action.

Marconi Multiple Tuner.



Reference No. 103 R. Code Word: *Atsinister.*

Patents Nos. 11575/1897, 12960/1907, 15909/1906, etc.

Special Pamphlet on application.

One Case.

Overall Dimensions $20\frac{3}{8} \times 9\frac{3}{8} \times 8\frac{1}{2}$ inches.

Weight 24 lbs.

Wave Range 100-2,500 metres.

This Tuner is specially constructed for use with the Magnetic Detector.

The Instrument can be fixed in any position suitable for easy handling of adjustments.

In cases where this Tuner with a Magnetic Detector is already fitted, and more sensitive detectors are required as alternative, crystal detectors can be supplied with the additional circuits necessary.

For ranges 200—1,800 metres, Case 2 of the Crystal Receiver (Ref. No. 108 R) is suitable for use with the Tuner.

For ranges 1,200—3,000 metres the Crystal Receiver (Ref. No. 112 R) is suitable.

Marconi Multiple Tuner—(Continued).

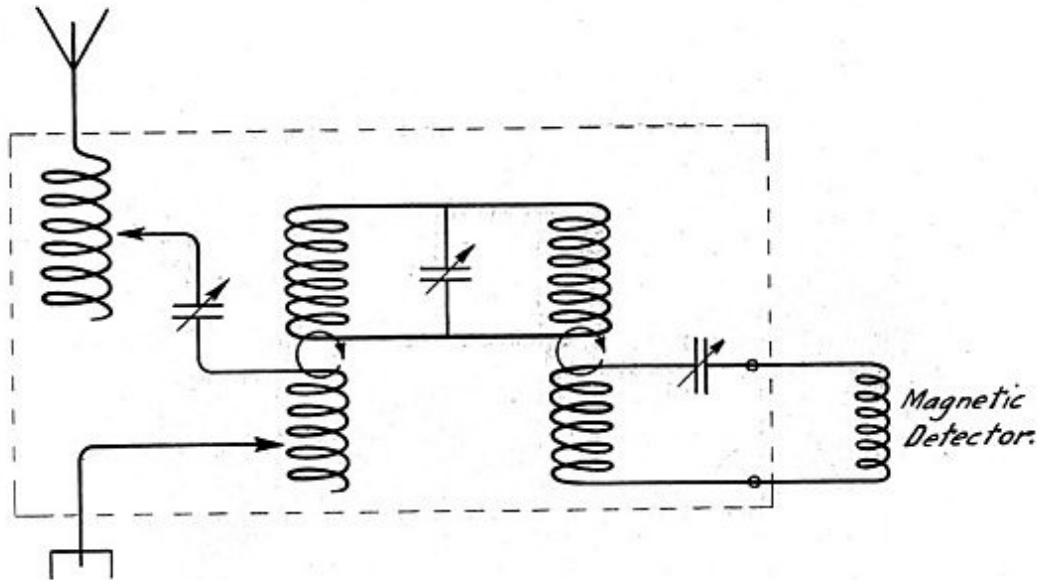

Diagrammatic View of Connections of Marconi Multiple Tuner.

The above diagram represents the connection of the Tuner when the switch is at 'TUNE.'

When the switch on the Tuner is at 'STD BI' the magnetic detector—which should be connected to the terminals marked 'detector'—is placed in series with the aerial, the aerial tuning inductance, the aerial tuning condenser, and the earth connection. This arrangement gives very flat tuning, enabling the operator easily to 'find' a station.

When the switch is at 'TUNE' the magnetic detector is placed in series with a condenser and self-inductance, which inductance is coupled inductively with another circuit called the intermediate circuit; and this intermediate circuit is again coupled with the aerial circuit. Each circuit in practice is adjusted to the wave-length being received. This arrangement gives very sharp tuning. The wave-length can be read off from the intermediate circuit with the help of a chart provided.

This Tuner is suitable for use on Ship or Shore Stations, particularly where sharp tuning is wanted, and the normal tuning given by the aerial circuit due to high earth resistance, etc., is not very good.

The wave range is sufficiently great to take in all wave lengths in practical use in connection with ship working.

Marconi Short Multiple Tuner.



Reference No. 104 R. Code Word: Attacker.

Patents Nos. 11575/1897, 15909/1906, etc.

Special Pamphlet on application.

One Case.

Overall Dimensions 13 × 9 × 9 inches.

Weight 13½ lbs.

Wave Range 250-1,750 metres.

Can be fixed in any position suitable for easy handling of adjustments.

This Tuner is specially constructed for use with the Magnetic Detector and low resistance telephones (Ref. No. 128 R).

In cases where this Tuner and the Magnetic Detector are already fitted and a more sensitive detector is required as alternative, Case 2 of Crystal Receiver (Ref. No. 108 R) is suitable, and will cover the complete range of the above Tuner.

Marconi Short Multiple Tuner—(Continued).

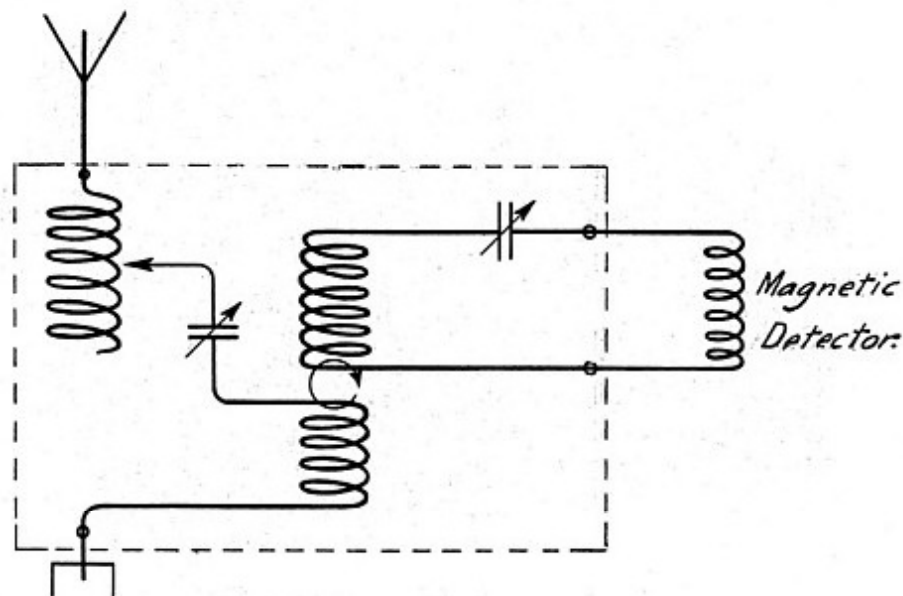

Diagrammatic View of Connections of Marconi Multiple Tuner (Short Range).

This Tuner is similar to the long range type except that the intermediate circuit is omitted, and consequently it is not suitable for highly damped aerials.

The range is intended to cover wave lengths used in ordinary ship practice.

Due to the omission of the intermediate circuit the tuning can be performed more rapidly than with the long-range Tuner. With ordinary ships' aerials the tuning will be found to be nearly as good.

The connections with the switch at 'STD BT' are arranged as before to give very flat tuning. When the switch is at TUNE, the connections are as shown (diagrammatically) above.

Marconi Valve Receiver.

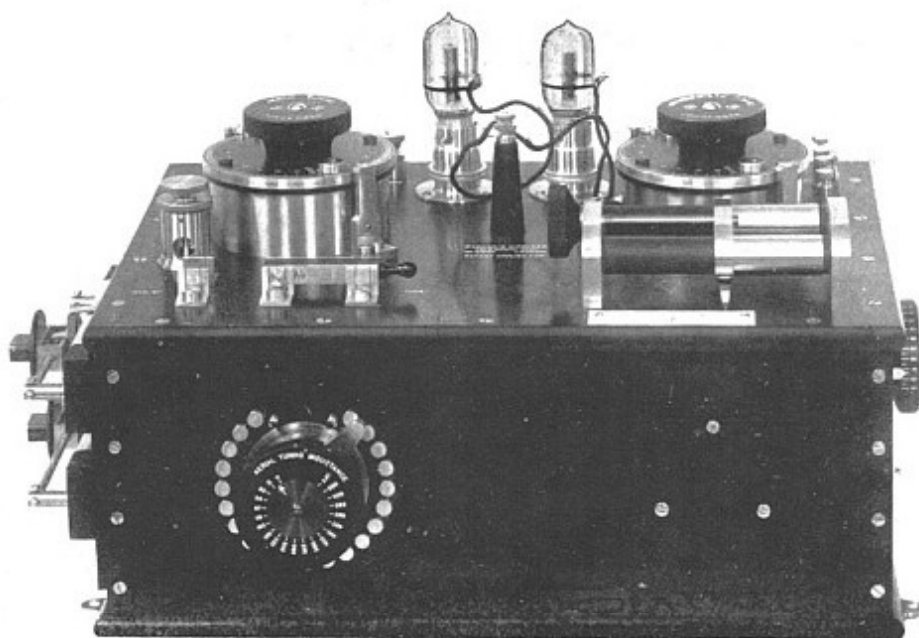

Reference Nos. 1051 R, 1052 R.
Code Words: *Arroncabe & Arrondimes.*

Patents Nos. 11575/1897, 12960/1907, 24850/1904, 887/1907, etc. Special Pamphlet on application.

One Case.

Overall Dimensions $19\frac{1}{4} \times 13\frac{1}{4} \times 10\frac{3}{8}$ inches.

Weight 27 $\frac{1}{2}$ lbs.

Wave Range { No. 1, 250-750 metres. No. 1051 R.
No. 2. 600-1,600 metres. No 1052 R

Can be fixed in any position suitable for easy handling of adjustments.

Additional Apparatus required.—A set of accumulators giving 6 volts, with charging arrangements. One pair of high resistance telephones or low resistance telephones and a transformer.

Crystal adapters can be supplied (Ref. No. 138 R).

Spare valves are required—average life, 1000 hours.

Marconi Valve Receiver—(Continued).

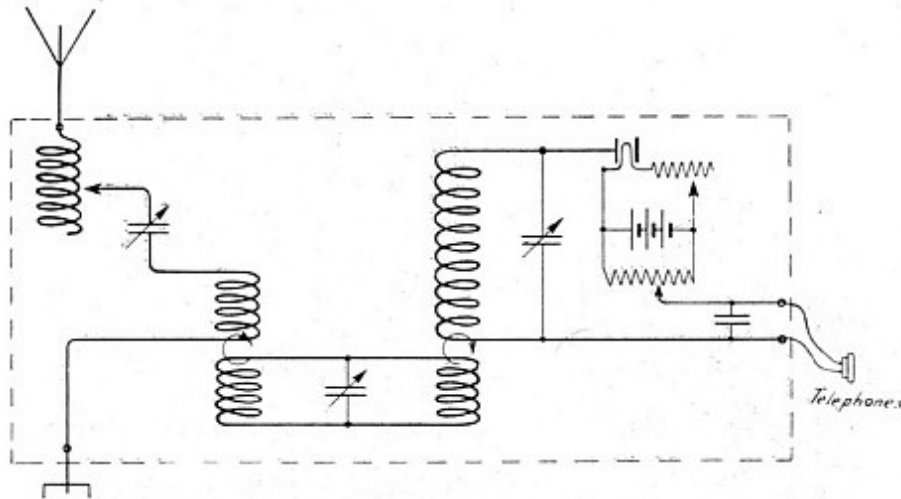

Diagrammatic View of Connections in Marconi Valve Receiver.

Detectors used.—2 valves (not balanced). Crystals can be supplied with adapters.

This Tuner is similar to the long range Marconi Tuner except that it is fitted with the Fleming oscillation valve, the third or detector circuit being adapted for this purpose. The receiver is complete in itself except for the accumulators and telephones.

'STAND BI' arrangements are provided as on the magnetic detector tuner.

The above diagram represents the principle of the connections when the switch is at tune.

This Receiver is next in order of robustness to the magnetic detector and is considerably more sensitive. A little more knowledge of adjustment is required than with the magnetic detector and tuner.

It is suitable for all cases where the magnetic detector is used if the operators are sufficiently expert at adjustments, and also if there are arrangements available for charging accumulators.

Marconi Valve Receiver (for long waves).

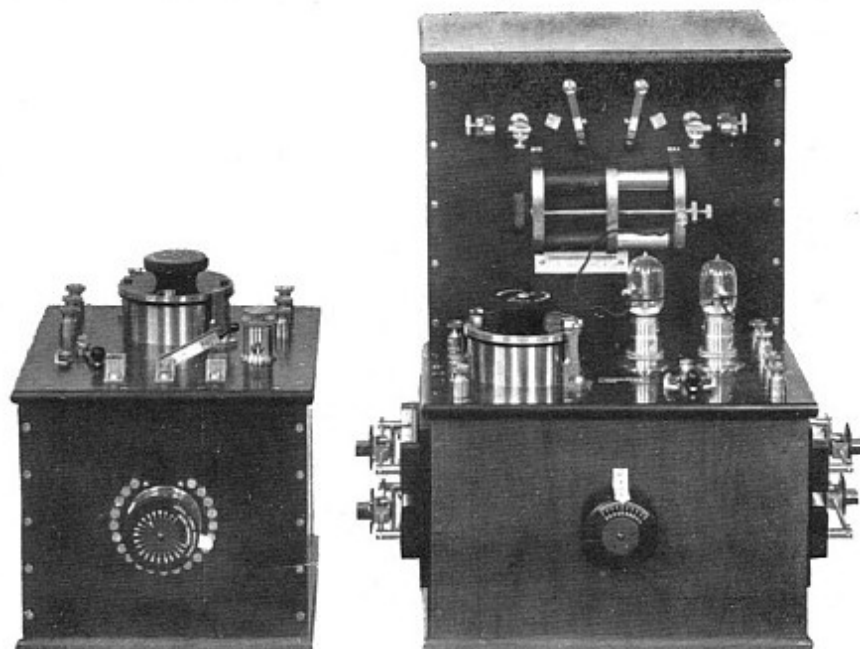

Case 1.

Case 2.

Reference Nos. 1061 R, 1062 R.

Code Words: *Arrostarsi. Arrotache.*

Patents Nos. 11575/1897, 12960/1907, 24850/1904, 887/1907, etc.

Two Cases.

Overall Dimensions { Case 1— $12\frac{1}{2} \times 10 \times 12$ inches.
Case 2— $17 \times 17 \times 19$ inches.

Weight { Case 1—20 lbs.
Case 2— $36\frac{1}{2}$ lbs.

Wave Range { No. 1—1,600-4,200 metres. No. 1061 R.
No. 2—Longer Ranges to order. No. 1062 R.

Suitable for fixing as in above block.

Additional Apparatus required.—High resistance telephones and adjustable disc condenser; or Telephone transformer, adjustable disc condenser, low resistance telephones, and telephone condenser. 6-volt accumulator with charging arrangements.

Spares required.—4-volt carbon valves.

This set is now usually fitted with balanced crystals in addition to valves.

The valves are not arranged for balancing.

Case 1 is suitable for use for aerial tuning with the magnetic detector, and terminals and a switch are provided so that the magnetic detector and valve can be used alternatively.

Marconi Valve Receiver (for long waves)—(Continued).

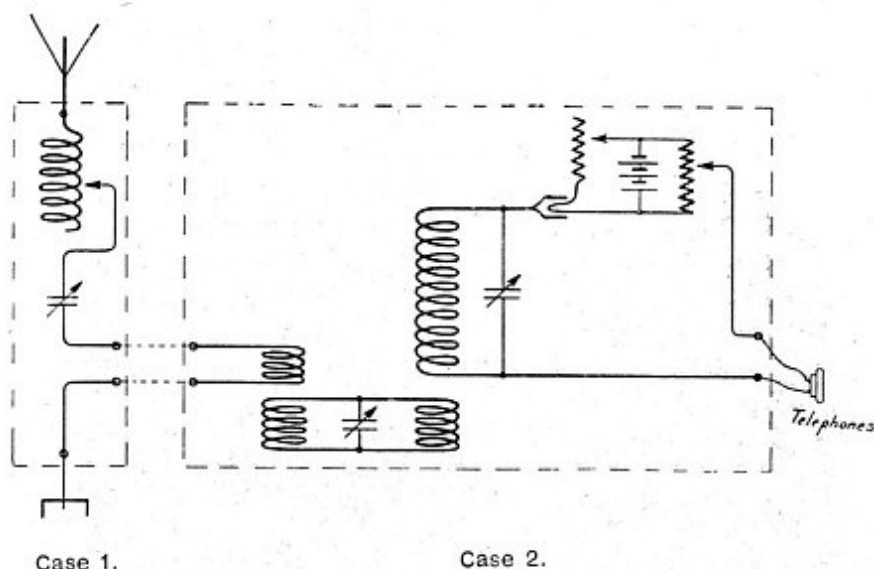

Diagrammatic View of Connections for Valves.

Detectors used.—2 valves (alternative and not balanced). Balanced crystals if required.

The circuits in this Receiver are very similar to those in the smaller valve receiver (No. 105 R), no 'STAND BI' however, being provided.

To obtain the highest efficiency with this set, a step-down transformer (No. 130 R) and low resistance telephones should be used.

The primary of the transformer should be shunted with an adjustable disc condenser and the telephones with the plug in type telephone condenser (No. 127 R).

This Receiver is suitable for long-distance land stations where reception over a great range of wave length is not required.

The detectors used are particularly suitable for large aerials and for use in countries where atmospheric discharges are bad. Neither the valve or crystals are thrown out of adjustment by violent discharges, such as are produced by local thunderstorms.

Scan by www.valve-radio.co.uk

16 MARCONI'S WIRELESS TELEGRAPH COMPANY, LIMITED.

Marconi Universal Crystal Receiver for Low Resistance Crystals.

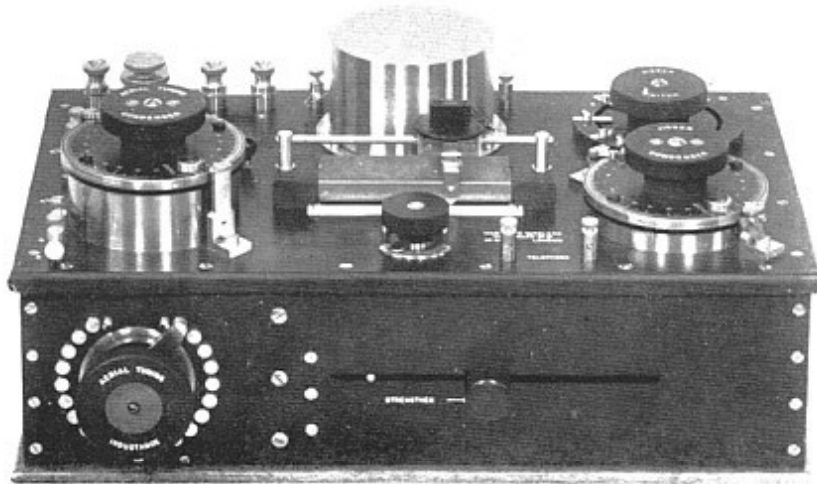

Reference No. 107 R. Code Word : *Arrosiphon.*

Patents Nos. 11575/1897, 15909/1906, etc.

Special Pamphlet in preparation.

One Case.

Overall Dimensions 17 × 12 × 8 inches.

Weight 20 lbs.

Wave Range 300–3,000 metres.

Additional Apparatus required.—High Resistance Telephones (129 R). Crystals set in cups.

Marconi Universal Crystal Receiver for Low Resistance Crystals

(Continued).

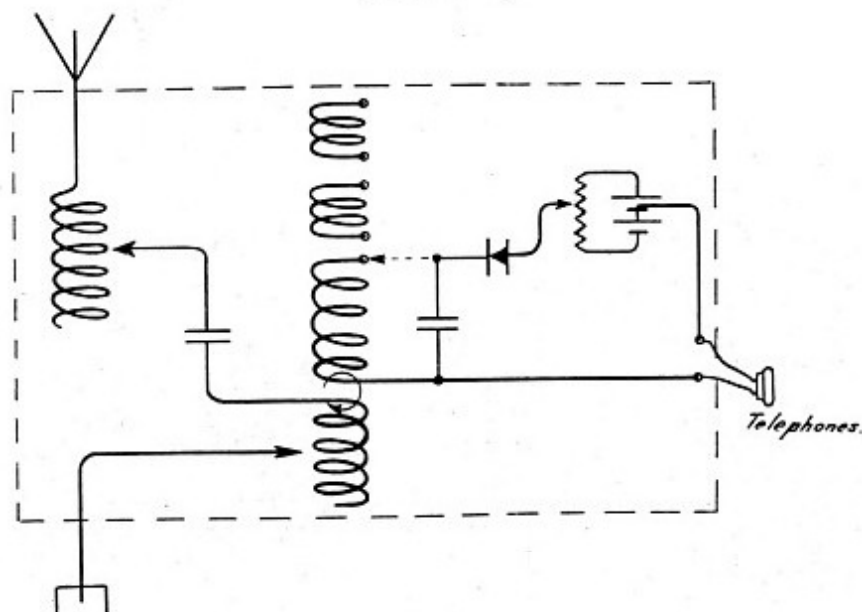

Diagrammatic View of Connections of Receiver.

Detectors Used.--Any Low Resistance Crystal or combination of crystals. Specially picked Carborundum is supplied.

The Receiver has been constructed for the use of those who prefer Low Resistance Crystals.

As these Crystals are particularly sensitive to disturbance from the local transmitter, a system of relays is provided, and also a metallic screen round the crystal to protect it.

This relay system works from the transmitting key, so that at the moment the spark occurs the crystal is protected. At all other times it is ready to receive.

There is no intermediate circuit, and the adjustments will be found to be extremely simple and easy to handle. The above diagram represents the arrangement of the circuits.

Marconi Balanced Crystal Receiver (short waves) With Intermediate Circuit.

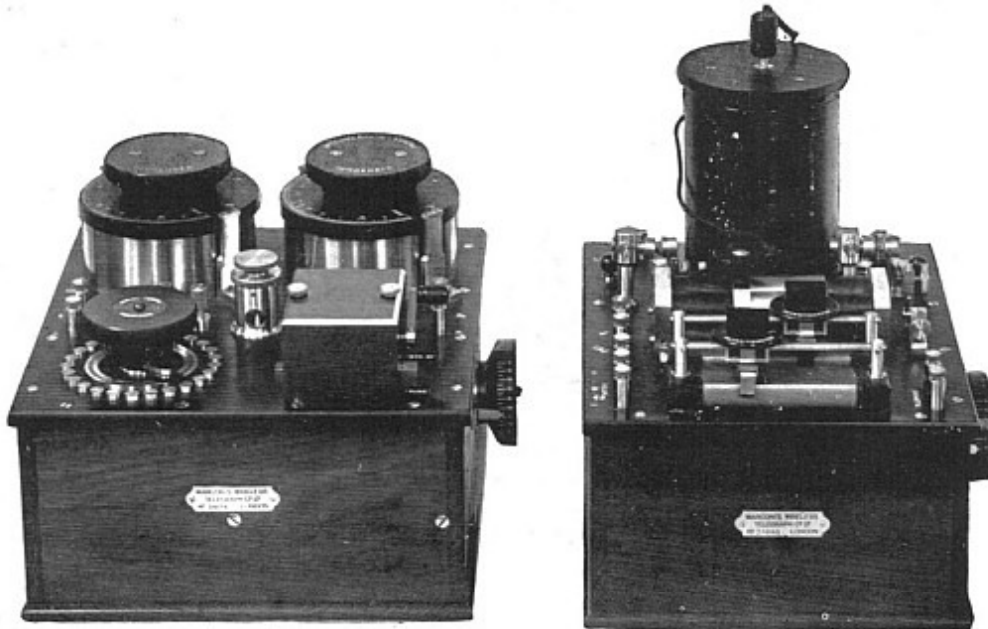

Case 1.

Reference No. 108 R.

Case 2.

Code Word: Arringando.

Patents Nos. 11575/1897, 15909/1906, 12960/1907, 5332/1907, 20441/1910, etc.
Special Pamphlet in preparation.

Two Cases.

Overall Dimensions { Case 1.—11 × 11 × 8½ inches.
Case 2.—9 × 11 × 16 inches.

Weight { Case 1—16½ lbs.
Case 2—15 lbs.

Wave Range 250-2,500 metres.

Suitable for fixing as in above block.

Additional Apparatus required.—2 dry cells, 1 pair low resistance telephones. (128 R).

Spares required.—Crystals set in cups. (136 R).

Case 1 can be used with the Magnetic Detector in place of the Marconi Multiple Tuner (Ref. No. 104).

Case 2 can be used in connection with either Multiple Tuner, in place of or alternative to the Magnetic Detector.

Marconi Balanced Crystal Receiver (short waves)

With Intermediate Circuit—(Continued).

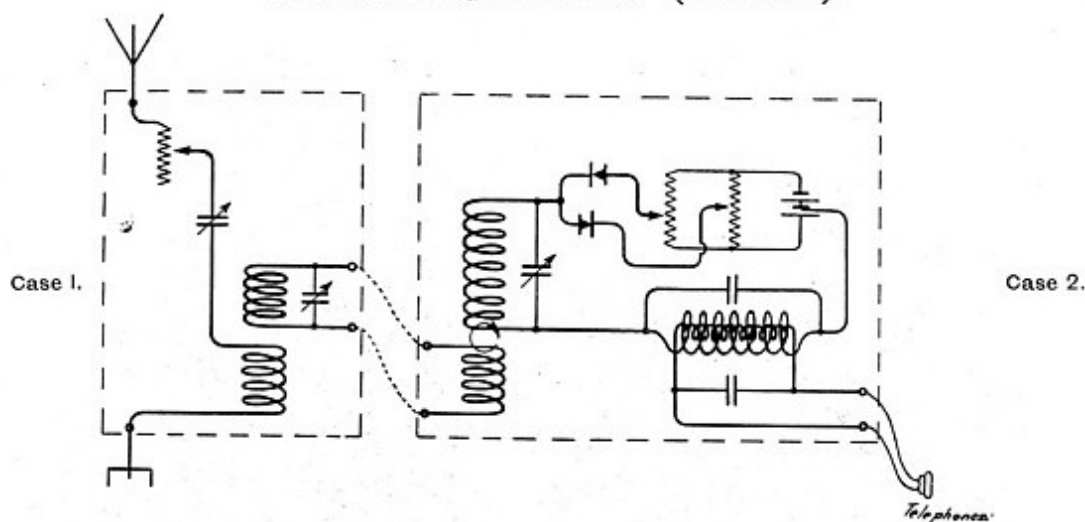

Diagrammatic View of Connections with Switch on 'Tune.'

Detectors used.—2 carborundum crystals (balanced).

This Receiver has been designed to incorporate all the latest methods for the reception of short-wave signals.

The crystal detectors consist of perfectly stable hard contacts, the adjustment of which are not affected by vibration, strong atmospheric discharges, or by jamming. The highest degree of sensitiveness and syntony has been maintained throughout the whole range by the correct design of the tuning circuits.

The apparatus requires considerable skill to use with full advantage. Also when the whole Receiver is in use, rapid changes of wave length are difficult to make, consequently a switch is provided which cuts out of action the intermediate circuit. Wave changes can then be made much more rapidly and a broad 'STAND BI' can be made by a close coupling between the aerial and crystal circuits. The Receiver can also be used in this position by almost anyone with a rough knowledge of tuning.

The crystals can be used either singly or together balanced. The method of balanced crystals, described in Patent No. 20441/1910 and in special pamphlets, enables atmospheric and strong jamming to be reduced considerably without reduction of signals. This effect is entirely independent of tuning, and quite easy to obtain with properly selected crystals.

Marconi Balanced Crystal Receiver (short waves) Without Intermediate Circuit.



Reference No. 109 R. Code Word: Arringerla.

Patents Nos. 11575/1897, 15909/1906, 5332/1907, 20441/1910, etc.
Special Pamphlet in preparation.

One Case.

Overall Dimensions $12\frac{1}{2} \times 11 \times 8\frac{1}{4}$ inches.

Weight 20 lbs.

Wave Range 250–3,800 metres.

Suitable for fixing as in the above block.

Additional Apparatus required.—2 dry cells, 1 pair Low Resistance Telephones (Ref. No. 128 R).

Spares required.—Crystals set in cups.

Marconi Balanced Crystal Receiver (short waves)

Without Intermediate Circuit—(Continued).

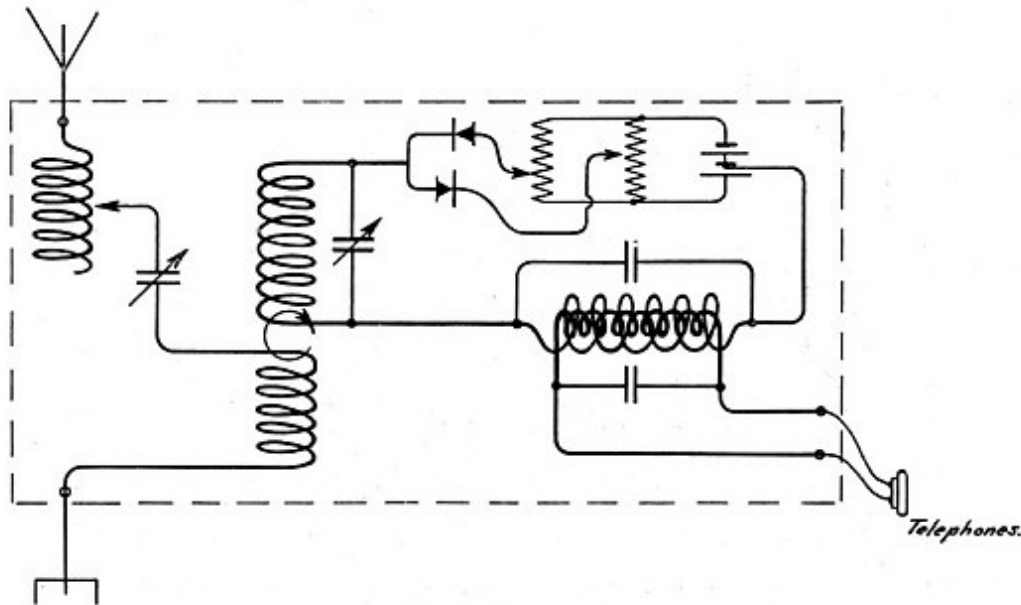

Diagrammatic View of Connection in Receiver.

Detectors used.—2 Carborundum Crystals (balanced).

This Receiver comprises in one case the arrangements of No. 108 R., except that the intermediate circuit is omitted. Less skill is therefore required to adjust the instrument, and on Ship Stations and Land Stations where the Aerial damping is small, the Receiver is almost as good a tuner as the more elaborate type (No. 108 R).

The instrument has the additional advantage that the jiggers are added by a simple switching arrangement, as in Receiver No. 107 R., instead of by the more complicated method of adding external inductances as in No. 108 R.

The Receiver has the highest order of sensitiveness between the ranges of 250 and 2,500 metres. Between the 2,500 and 3,800 metres the sensitiveness is not so great as Crystal Receiver No. 110 R, and the latter Receiver should be used where the chief working ranges are over 2,500 metres.

Marconi Valve and Balanced Crystal Receiver (long wave).

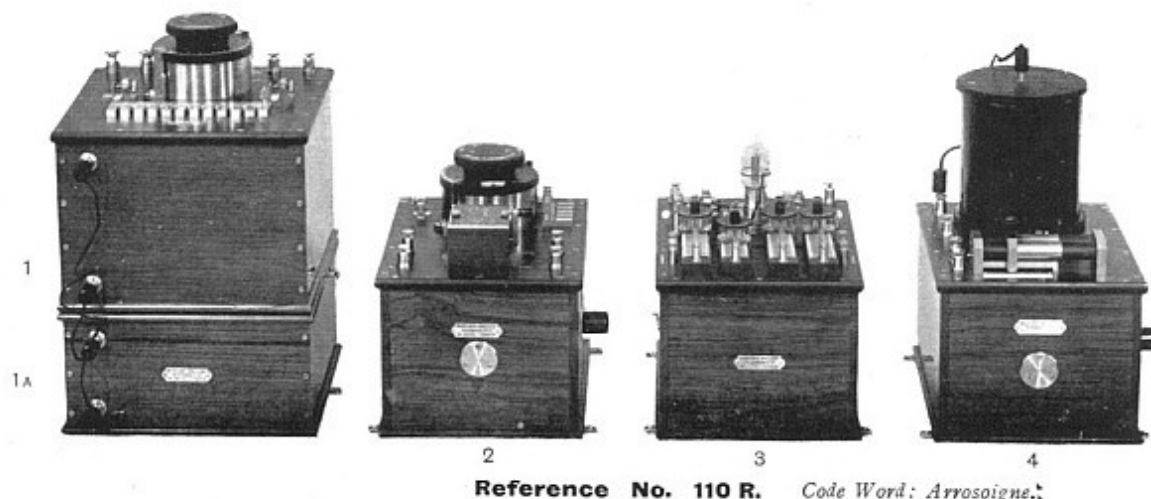

Patents Nos. 11575/1897, 15909/1906, 12960/1907, 20441/1910, etc.

Special Pamphlet in preparation.

Four or more Cases for Complete Receiver :

- | | | | |
|---|--|------|---------------------|
| Case 1. Aerial Tuning Inductance, condensers, etc. | | | |
| Overall dimensions : | $10\frac{1}{2} \times 11 \times 10$ inches | | Weight 9 lbs. |
| Case 1a. Additional Tuning Inductance in units as required. | | | |
| Overall dimensions : | $10 \times 10 \times 5$ inches | | Weight 6 lbs. |
| Case 2. Intermediate Circuit (optional). | | | |
| Overall dimensions : | $9 \times 11\frac{1}{2} \times 10$ inches | | Weight 15 lbs. |
| Case 3. Crystals, Valves, etc. | | | |
| Overall dimensions : | $9 \times 11\frac{1}{2} \times 10$ inches | | Weight 15 lbs. |
| Case 4. Jigger Circuits. | | | |
| Overall dimensions : | $9 \times 10\frac{1}{2} \times 17$ inches | | Weight 12 lbs. |

Wave Range.—1,000–7,000 metres.

Suitable for fixing as in above block.

Additional Apparatus required.—6-volt accumulator if valve is to be used. 1 pair low resistance telephones.

Spares required.—Crystals and valves. Dry cells replaced occasionally.

Marconi Valve and Balanced Crystal Receiver (long wave)

(Continued).

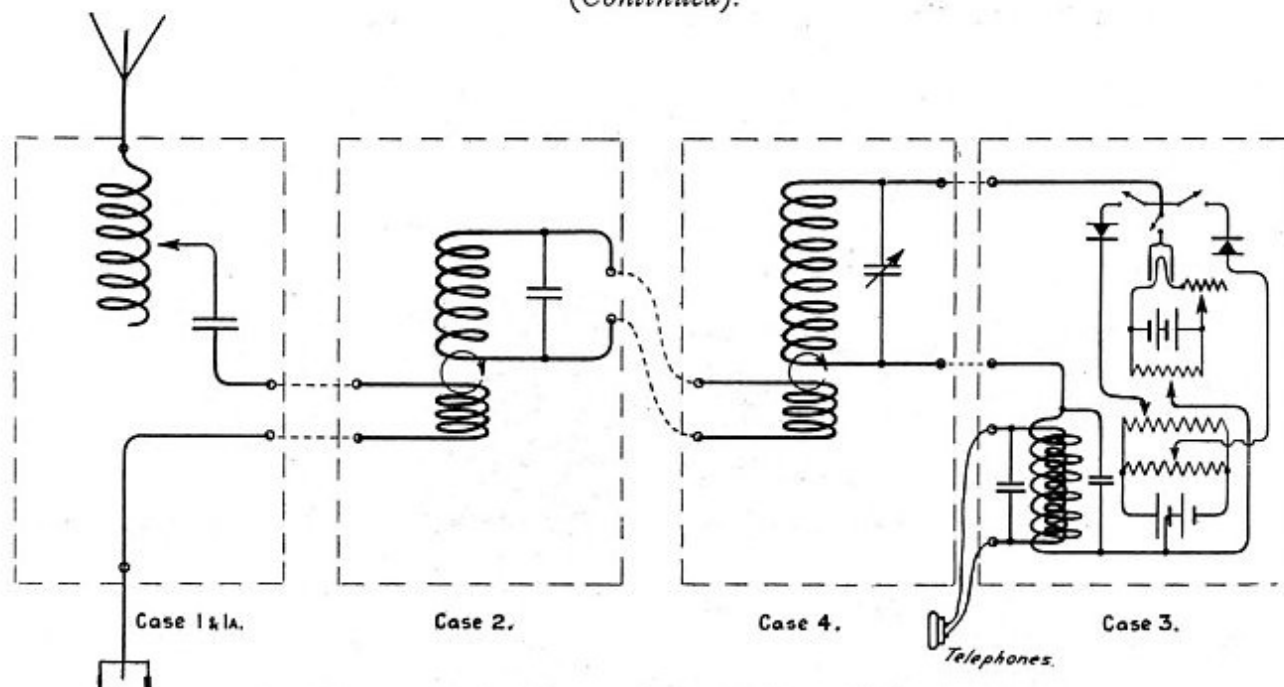

Diagrammatic View of Connection of Receiver.

Detectors used.—1 limiting valve (4-volt carbon); 2 carborundum crystals (balanced).

This Receiver contains all the latest improvements for the reception of long waves except from those stations giving continuous waves. It is adaptable to different receiving conditions. Case 1 contains sufficient aerial tuning inductance for receiving the longest wave when the aerial is over two thousand feet in length, but for smaller aerials additional units Case 1a will be necessary.

The intermediate circuit, Case 2, can be omitted if the aerial is comparatively short as sufficient tuning will be given by the aerial circuit. The switch on the intermediate case enables the intermediate circuit to be cut out with one movement.

The above diagram represents the connections when the intermediate circuit switch is at 'TUNE.' The valve battery is external, and the battery box, 141 R, is suitable with a 6-volt accumulator. The valve and crystals are alternative receivers, and the arrangements for them are of the latest type—for the prevention of interference by atmospherics.

It is advisable to use this Receiver in connection with a Wavemeter (No. 1221 R) and a shunted high-note buzzer placed near the earth wire. This enables adjustments to any wave-length to be carried out rapidly.

Marconi Crystal Receiver. No. 1.

(For the reception of News, Time Signals, and Weather Reports.)

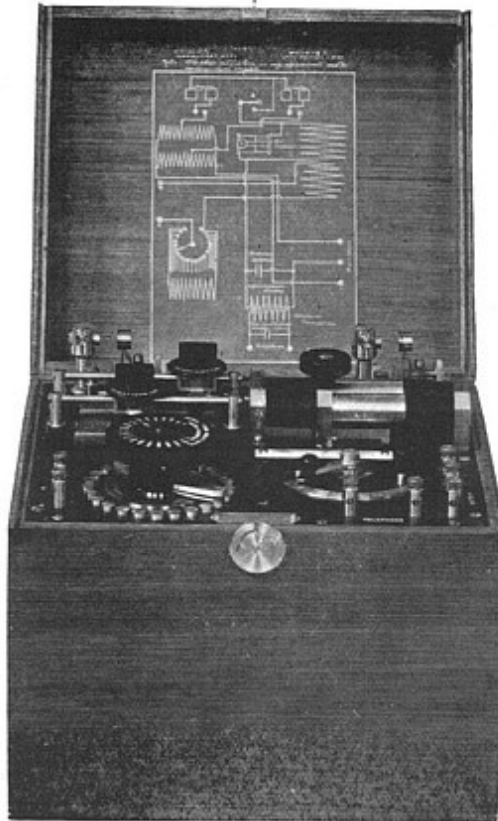

Reference No. 111 R. Code Word: Arrivabile.

Patents Nos. 11575/1897, 20441/1910, etc.

One Case.

Overall Dimensions 11 × 10 × 10 inches.

Weight 18½ lbs.

Suitable for fixing in any position.

Hinged lid removable by sliding sideways.

Additional Apparatus required—1 pair low resistance telephones, 2 dry cells.

Wave Range—1,100–3,000 metres.

Spares required.—Crystals set in cups. Dry cells will need occasional replacing.

Marconi Crystal Receiver. No. 1—(Continued).

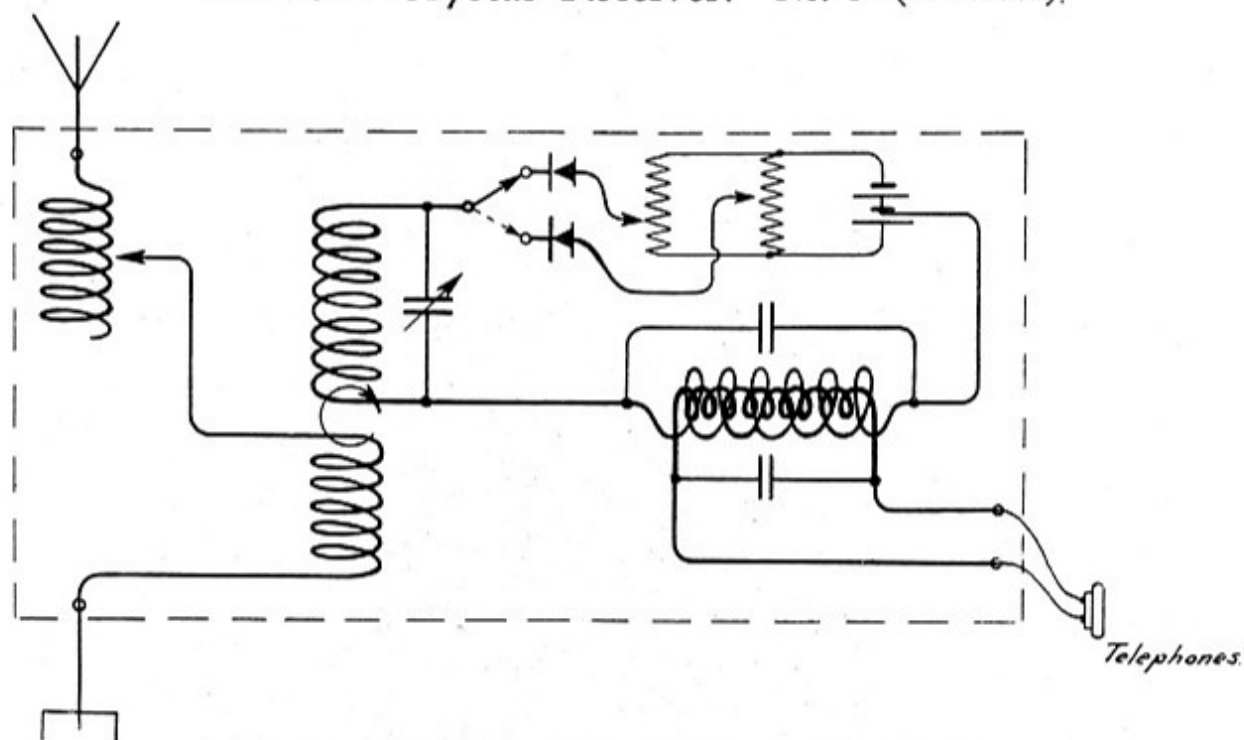

Diagrammatic View of Crystal Receiver Connections.

Detectors used.—2 carborundum crystals.

This Crystal Receiver is specially designed for use on board ship for the reception of news and time signals. It is complete except for two dry cells and a pair of low resistance telephones. The lid can be closed up when the Receiver is not in use, or the lid can be removed and the Receiver mounted in any desired position.

The Receiver is designed for fairly long waves, on small aerials such as those on ships, and consequently no aerial tuning condenser is provided. The tuning positions of Poldhu and Cape Cod and the Eiffel Tower are marked on the chart provided. Two alternative crystals are provided, each with its own potential changer. This arrangement has been found to be extremely convenient, as it enables one to test crystals very quickly against a standard. This Receiver is the most sensitive and reliable Receiver obtainable for receiving news. The adjustments also are extremely simple.

The box is also portable and can be provided with a carrying strap if required.

Marconi Crystal Receiver. No. 2.

For the reception of News and Time Signals.

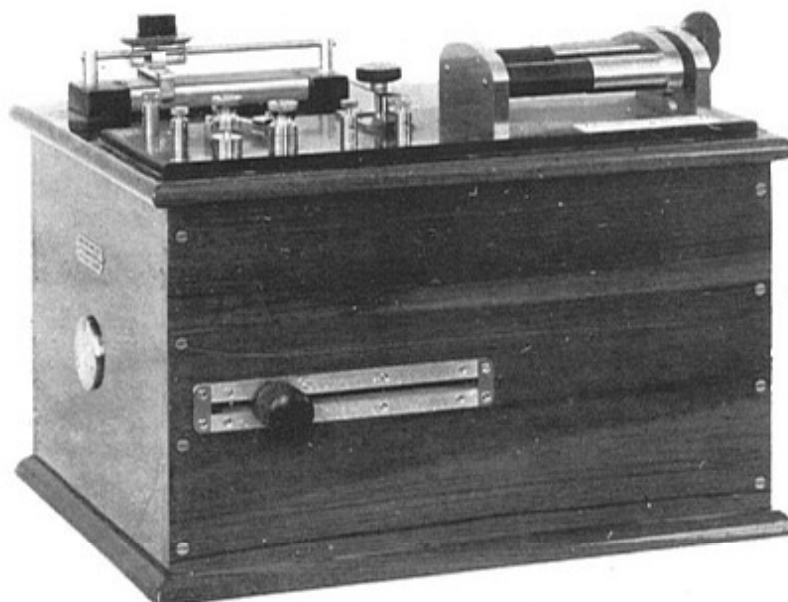

Reference No. 112 R. Code Word: *Arrivames.*

Patent No. 5332/1907, etc.

One Case.

Overall Dimensions 15 × 12 × 11½ inches.

Weight 16½ lbs.

Additional Apparatus required.—High resistance telephones and multiple tuner or aerial tuning inductance.

Wave Range 1,700–4,000 metres.

Also wound for 300–1,700 metres if required.

Suitable for fixing in any position.

Spares required.—Crystals set in cups.

2 dry cells.

Marconi Crystal Receiver. No. 2—(Continued).

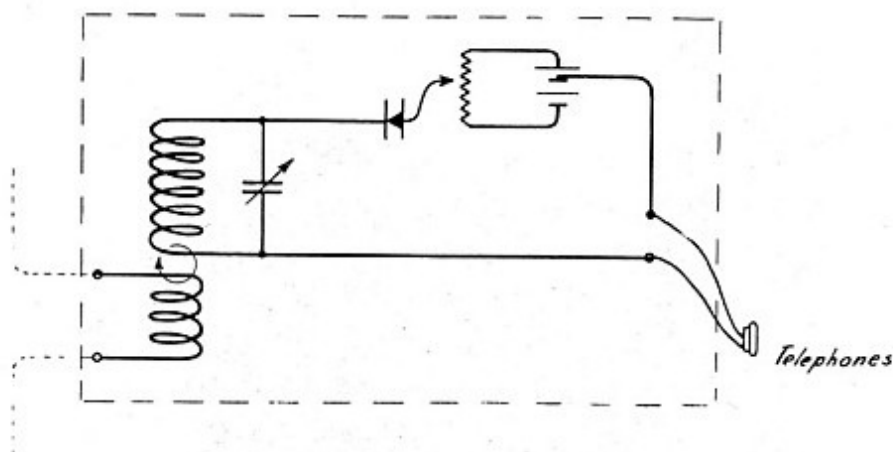

Diagrammatic View of Crystal Receiver Connections.

Detectors used.—Single carborundum crystal.

This Receiver is intended for use on ships where a multiple tuner (103 R) is already provided, no aerial tuning inductance or condenser being included.

The adjustments for Poldhu, Cape Cod, etc., are marked on the chart provided.

This Receiver is extremely sensitive and reliable. The adjustments also are very simple. When used with the multiple tuner (103 R) it should be connected in place of the magnetic detector. As a usual thing, tuning will be quite good with the tuner switch at 'STD BI' and it is not necessary to use the 'TUNE' position on the tuner. The signals from Poldhu should be several times as loud as those received on a magnetic detector; if they are not, then either the adjustment is wrong or the crystals are not good ones, and they should be changed.

If a tuner is not available and the aerial is a normal ship's aerial, an aerial tuning inductance, variable, continuously, or in small steps, will be necessary.

Marconi Demonstration Crystal Receiver.

No. 1.

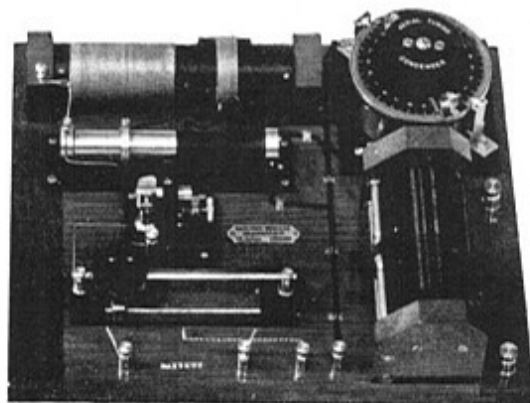

Reference No. 113 R. *Code Word: Arrisovab.*

Patents Nos. 11575/1897, 15909/1906, 5332/1907, etc.

On Baseboard.

Overall Dimensions 15 × 12 × 4¼ inches.

Weight 9 lbs.

Range Usual, 100–200 metres.

(Other ranges can be supplied on request.)

Additional Apparatus required.—Two dry cells and 1 pair high resistance telephones.

Spares required.—Crystals in cups.

Marconi Demonstration Crystal Receiver. No. 1.

(Continued).

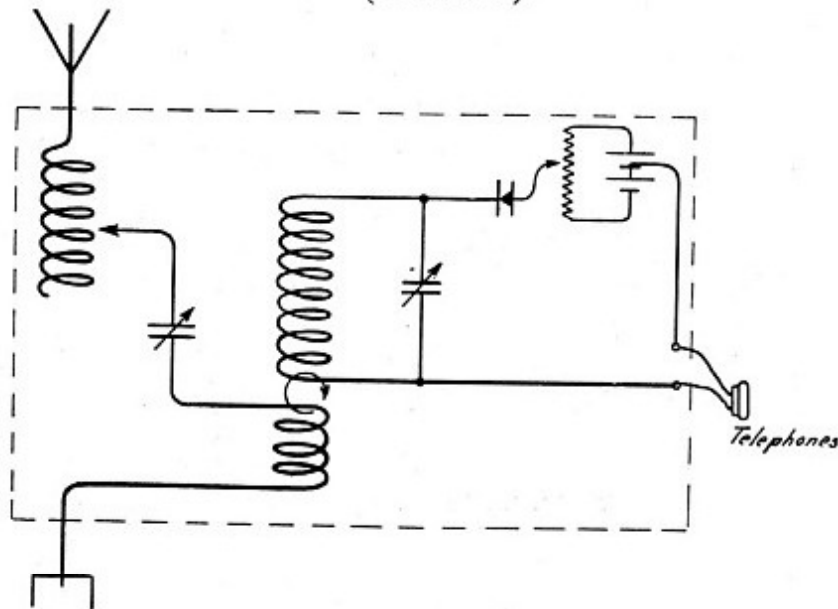

Diagrammatic View of Connections of Crystal Receiver.

Detectors used.—1 carborundum crystal.

This Receiver is intended to be used in connection with the demonstration transmitter with wave lengths well outside those which would interfere with commercial stations.

It is equally suitable for demonstrating over a hall or over several miles, the range depending upon the height of aerial used.

With a clear aerial height of 30 feet at both ends a distance of 6 miles can easily be worked with the demonstration receiver and transmitter.

Many experiments can be carried out with this Receiver, and at the same time the experimenter can clearly follow the changes that he is making. The connections are the Marconi Crystal receiving standard connections, and those who become acquainted with this instrument will readily be able to use any of the more elaborate Receivers.

Marconi Short Wave Portable Set.

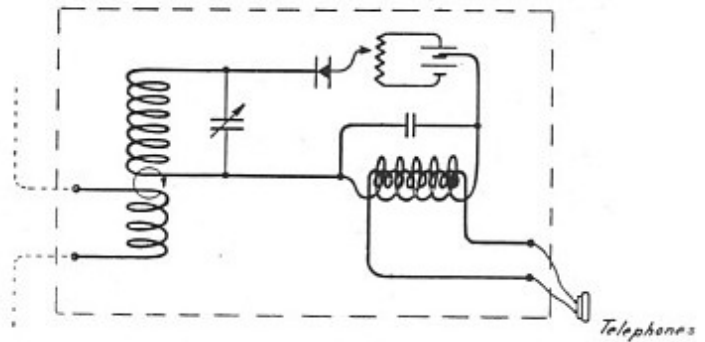

Reference No. 114 R. Code Word: *Arrosaur.*

Patents Nos. 887/1907, 5332/1907, etc.

One Case.

Overall Dimensions $12 \times 7\frac{1}{4} \times 5\frac{3}{4}$ inches.

Weight 8 lbs.

Wave Range 185-340 metres.

(Other ranges as desired.)

Portable; leather carrying strap.

Intended for use with fixed aerial and fixed transmitting wave. No aerial tuning arrangements provided.

The Wireless Direction Finder

(Marconi Bellini Tosi System).

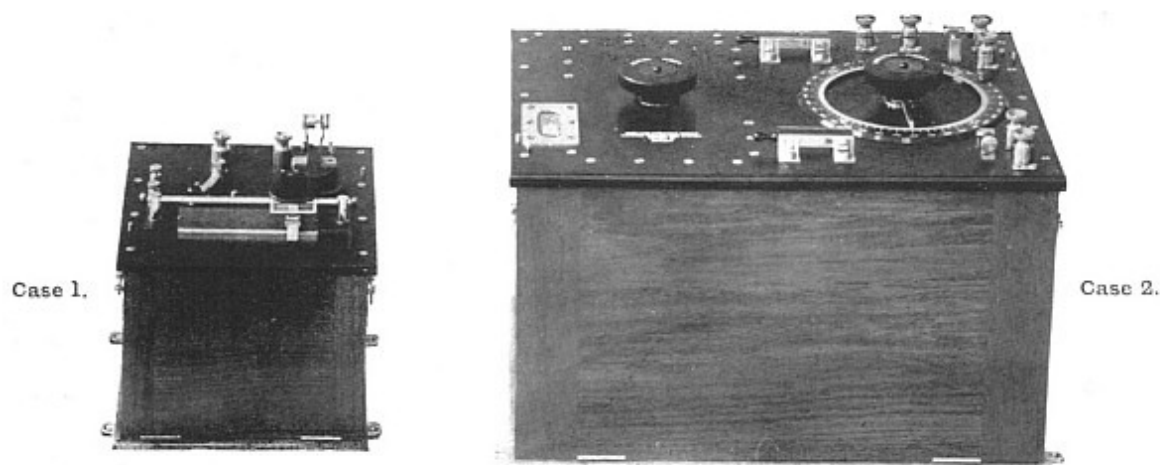

Direction Finder with Untuned Receiver.

Reference No. 116 R. Code Word: *Agamerac.*

Patents Nos.

Special Pamphlets on application.

Two Cases.	Case 1.	Case 2.
Overall Dimensions	8 × 9 × 10 inches	12 × 17 × 12 inches.
Weight	10 lbs.	50 lbs.
Wave Range	determined by aerials used.	

The Direction Finder or Wireless Compass is intended for use with frame type aerials. Two of these aerials are arranged at right angles in a convenient place, the area enclosed by each frame being made as large as possible.

The above set has been designed with as little variable adjustment as possible, so that it can be used by those not particularly expert with wireless apparatus.

The range depends upon the size of the aerials and the power of the sending station, and varies from ten to fifty miles.

The Direction Finder—(Continued).

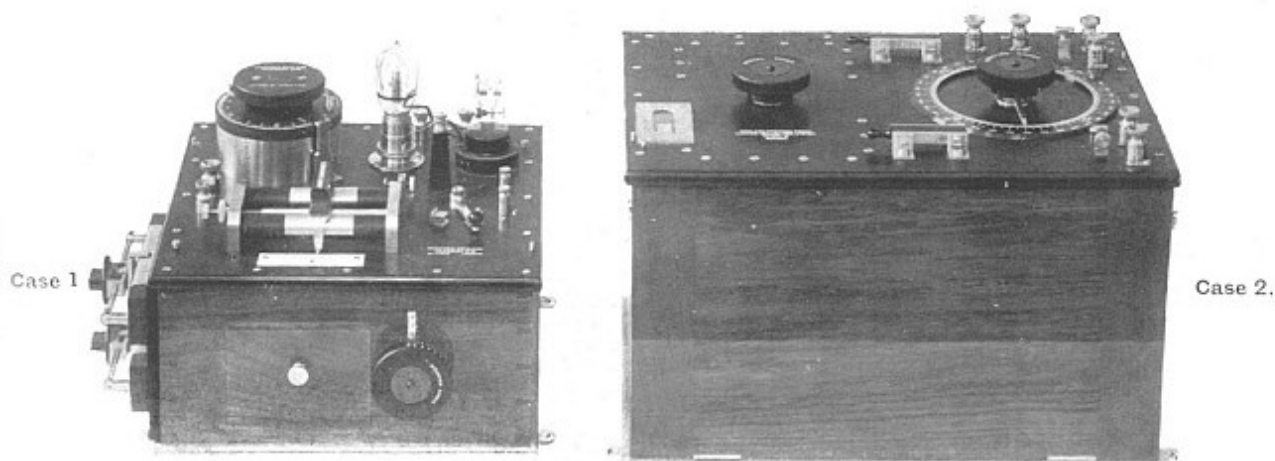

Direction Finder with Tuned Receiver.

Reference No. 117 R. Code Word: Agaldish.

Patents Nos.

Special Pamphlets on application.

Two Cases.	Case 1.	Case 2.
Overall Dimensions ...	12 × 12 × 13 inches	12 × 17 × 12 inches.
Weight	23 lbs.	50 lbs.
Wave Range	280-640 metres.	

The Tuned Receiver enables an increase in distance of about 50 per cent. to be obtained over that obtained with the Untuned Receiver.

Valves or crystals are fitted.

More knowledge of adjustment is required than with the Untuned Receiver, and more attention has to be paid by the operator to the Receiver.

With either Receiver directions of wireless stations can be determined within 4 degrees and under favourable conditions, within 1 degree.

Marconi Wavemeters. Nos. 1 and 2.



Reference Nos. 1181 R, 1182 R.
Code Words: *Aubprate & Aubquint.*

Patents Nos. 26588/1908, 15909/1906, 5332/1907, etc.

Special Pamphlet on application.

One Case.

Overall Dimensions $9\frac{5}{8} \times 6\frac{1}{2} \times 4\frac{1}{2}$ inches.

Weight 7 $\frac{1}{2}$ lbs.

Wave Range ... { No. 1—100–800 metres. No. 1181 R.
No. 2—100–2,500 metres. No. 1182 R.

Additional Apparatus required.—None.

Shunted Buzzers can be supplied for use with this Wavemeter to tune up receiving circuits.

If required, these Wavemeters can be constructed for any range of wave length. Thermo ammeters for curve plotting can also be supplied.

Marconi Wavemeters. Nos. 1 and 2—(Continued).

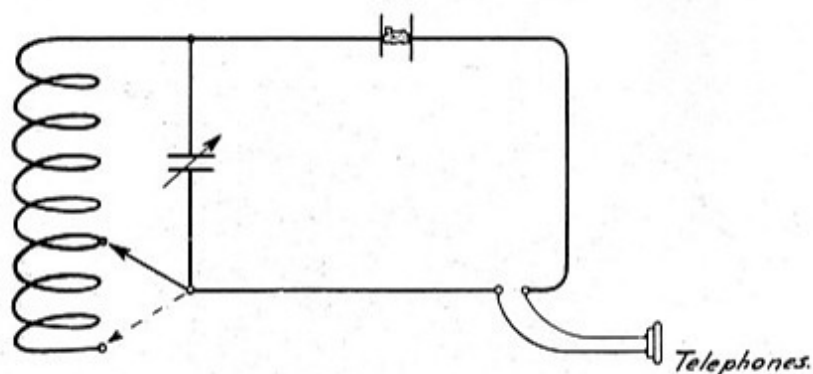

Diagrammatic View of Wavemeter.

This Wavemeter is the most practical instrument of its kind that has been introduced. It is extremely portable and self-contained.

Wave lengths can be measured very rapidly, one minute being usually sufficient time to measure within .75 per cent. providing the transmitting wave is not too damped.

In the latest type of instrument all the old defects in the condenser, such as brush contacts, have been eliminated.

The instrument is far more sensitive than any Wavemeter using galvanometers or vacuum tubes, and consequently waves not otherwise detectable can be measured with great ease.

Used as a miniature transmitter with a shunted high-note buzzer and a dry cell, many receiving tests can be carried out without having resource to a distant station.

Marconi Direct Reading Decremeter.



Reference Nos. 1211 R, 1212 R.
Code Words: *Adelavero. Advelent.*

Patents Nos. 185/1909, 15909/1906, etc.

Special Pamphlet on application.

One Case.

Overall Dimensions { No. 1—16 × 10 $\frac{1}{4}$ × 5 inches
No. 2—18 $\frac{1}{2}$ × 11 $\frac{1}{2}$ × 5 $\frac{1}{4}$ inches

Weight No. 1—16 lbs.; No. 2—22 lbs.

Wave Range { No. 1—100–700 metres. No. 1211 R.
No. 2—400–3,000 metres. No. 1212 R.

Portable; can be used in any convenient position.

Additional Apparatus required.—None.

Spares.—None.

These instruments can be used also as wavemeters. Thermo ammeters can be supplied for curve plotting if preferred to the telephone method. High-note Shunted Buzzers can also be provided for converting the instrument into a transmitter for receiving experiments.

Marconi Direct Reading Decremeter—(Continued).

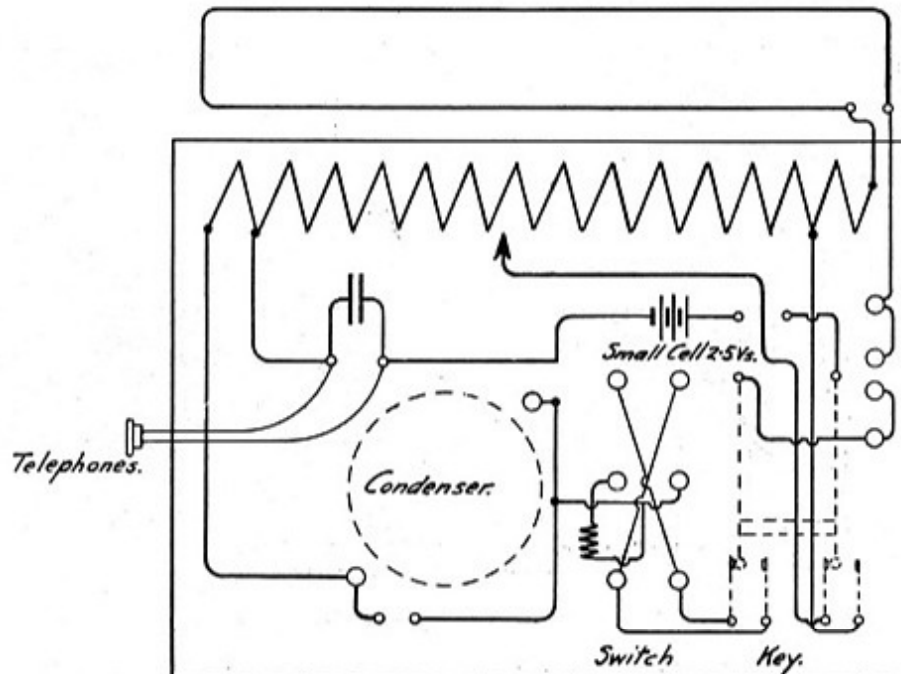

Diagrammatic View of Connections of Decremeter.

When an attempt is made to measure the damping of a spark-excited circuit by Drude's method it will be found that the curves obtainable are extremely irregular, especially near the resonant point, except in a few cases, as, for example, when the spark is produced by a Marconi Disc Discharger running at a very constant speed.

As a very slight difference in the curve, especially at the maximum, makes a very big change in the value of decrement calculated from the curve, different measurements will produce results differing by hundreds per cent. from one another.

The Marconi Decremeter substitutes a telephone and rectifier for the thermo ammeter.

A very simple sliding arrangement enables the complicated Drude equations to be solved automatically, the operator merely having to equalise two sounds and read the decrement from the table inside the lid.

The instrument constitutes a very exact wavemeter, and the variable condenser is carefully calibrated and charted so that almost any measurement required in wireless work can be made.

Marconi Long Wave Decremeter and Wavemeter.

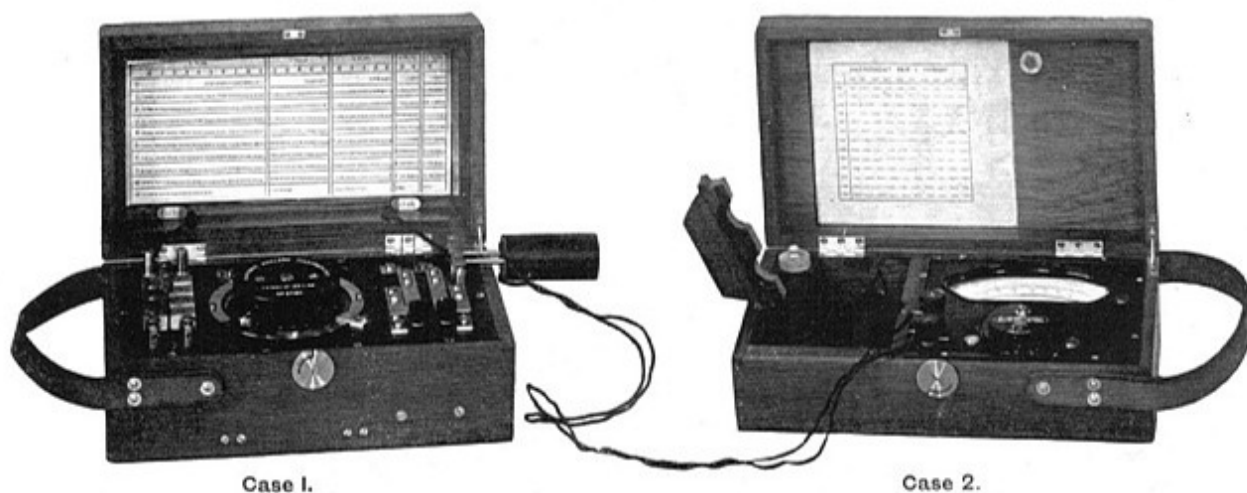

Case 1.

Case 2.

Reference Nos. 1221 R, 1222 R.

Code Words: Aderamos & Aderend.

Patents Nos. 26588/1908, 15909/1906, etc.

Special Pamphlet on application.

Two Cases.

Case 1—Overall Dimensions No. 3—13×8×5 inches; No. 4—13×8×6 inches.
 Weight No. 3—11½ lbs.; No. 4—13½ lbs.

Case 2—Overall Dimensions No. 3—13×8×4 inches; No. 4—13×8×4 inches
 Weight No. 3. 9 lbs. No. 4 9 lbs.

Wave Range.—No. 3, 1,200–10,000 metres. **No. 1221 R.**

No. 4, 4,000–30,000 metres. **No. 1222 R.**

If either of these Instruments are required as a Wavemeter alone, Case 2 is not required.

Additional Apparatus required.—None.

Spares required.—None.

This instrument can also be used as a transmitter for receiving experiments, and for this purpose a High-note Shunted Buzzer can be supplied.

Case 2 contains a sensitive direct current galvanometer, and two thermo junctions, and is adaptable for measurements besides those of decrement—the galvanometer being particularly useful for the testing of detectors (see Special Pamphlets on Detectors).

Marconi Long Wave Decremeter and Wavemeter—(Continued).

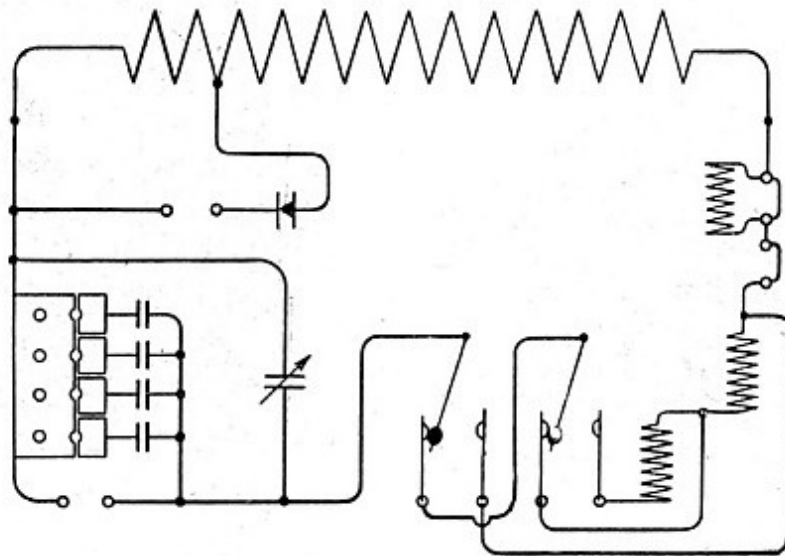

Diagrammatic View of Connections of Case 1 of Decremeter.

This instrument has been introduced for use on large power stations where extremely long waves are transmitted, and where the generators are sufficiently steady to enable curves to be plotted.

By means of it a great many measurements can be carried out on a power station—such as wave length, coupling, decrement, inductance and capacity.

By means of a Shunted Buzzer waves of any frequency and damping can be produced to actuate the receiving circuits.

Quantitative experiments with receivers can be carried out with the decremeter, as the thermojunction supplied enables the oscillating current produced by the Shunted Buzzer to be measured.

Buzzer Ref. No. 143 R is recommended for this purpose. Oscillation energy of about $\frac{1}{20}$ watt is produced by this Buzzer actuating the decremeter.

Combined Condensers and Inductances, And Inductances in Units.

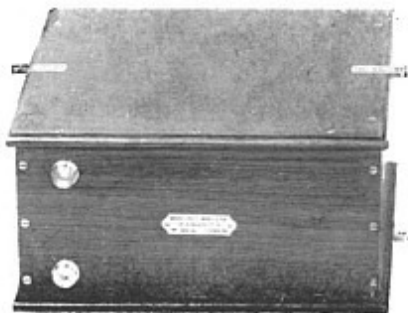

Reference No. 123 R. Code Word : *Androzita.*

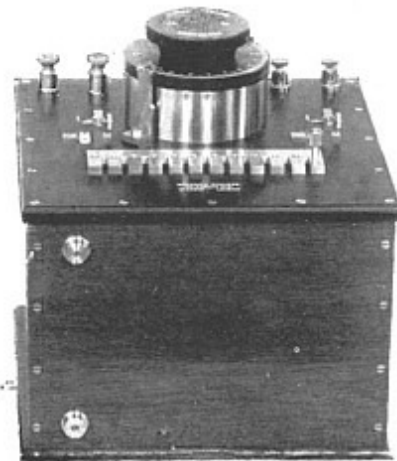

Reference No. 124 R. Code Word : *Acroomis.*

Patents Nos. 15909/1906, 11575/1897.

These Inductances and Combined Condensers and Inductances are suitable for many purposes.

They can be supplied carefully calibrated if necessary. They are primarily intended for use as aerial tuning devices, and it should be noted that the condenser in 124 R is shunted with a fine wire inductance of great value to absorb static charges.

The condensers have extremely small dielectric losses, and the inductances are wound of stranded wire to reduce resistance losses to a minimum.

No. 123 R.	Overall Dimensions	10 × 10 × 5 inches.
	Weight	6 lbs.
	Inductance in Microhenries	400
No. 124 R.	Overall Dimensions	10½ × 11 × 10 inches.
	Weight	9 lbs.
	Maximum Inductance in Microhenries	700
	Maximum Capacity in Microfarads	·012

Nos. 123 R, and 124 R are fitted with brass connecting plates to enable them to be connected in series.

Variable Condensers.



Reference No. 125 R. Code Word: Actinique.

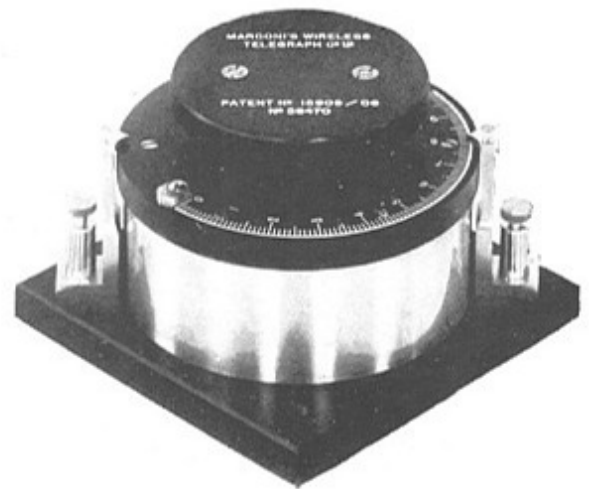

Reference No. 126 R. Code Word: Actionist.

Patent No. 15909/1906.

No. 125 R.	Overall Dimensions	$4\frac{5}{8} \times 4\frac{5}{8} \times 3\frac{1}{4}$ inches.
	Weight 3 lbs.
No. 126 R.	Overall Dimensions	$4\frac{3}{4} \times 4\frac{3}{4} \times 3\frac{1}{2}$ inches.
	Weight $3\frac{1}{4}$ lbs.

Both Condensers have ebonite for dielectric, and are constructed to have the largest possible capacity for their size.

No. 125 R is variable continuously from zero to .01 mfd.

No. 126 R „ „ „ zero to .012 mfd.

No. 126 R is the latest type and has no brush contacts ; thus there is no liability of bad contacts forming.

The dielectric loss in these Condensers is extremely small and for all practical purposes they are the equal of air condensers—the dimensions being very much smaller than any variable air condenser of equal capacity.

Telephone Condensers.



Reference No. 127 R. *Code Word: Acoustic.*

Overall Dimensions 3 × 5 × 6 inches.

Weight 3 lbs.

These Condensers are variable in steps up to a maximum of .2 mfd. They are used for shunting low resistance telephones in receivers where the shunting capacity is not otherwise provided.



Reference No. 128 R. *Code Word: Atemyrtle.*



Reference No. 129 R. *Code Word: Atenautic.*

Telephone No. 128 R is the standard 150 ohm telephone used by the Marconi Company, and is suitable for all Receivers requiring a low resistance telephone.

Telephone No. 129 R is the standard 8,000 ohm telephone used by the Marconi Company, and is suitable for all Receivers requiring high resistance telephones.

More sensitive Telephones of any resistance can be supplied to order.

Telephone Transformers.

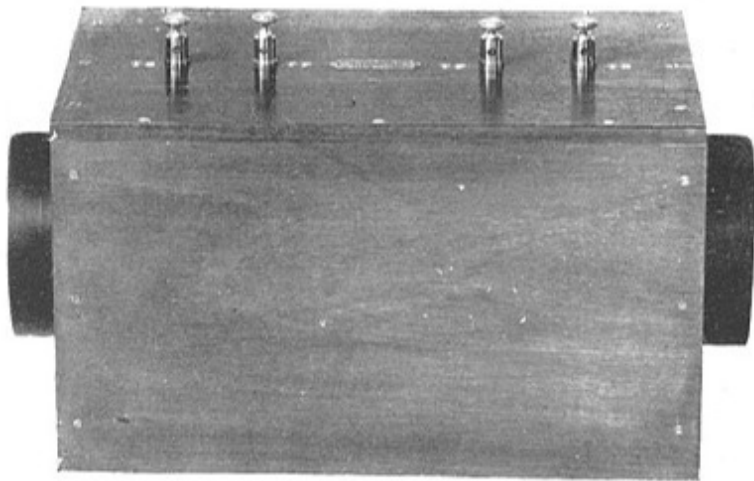

Reference No. 130 R.
Code Word : Atemuriate.

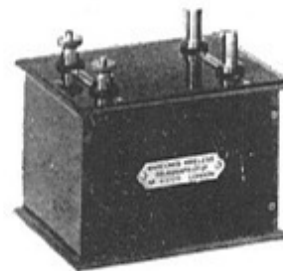

Reference No. 131 R.
Code Word : Atemustic.

Patent No. 887/1907.

No. 130 R.	Overall Dimensions	17 × 8 $\frac{1}{4}$ × 9 $\frac{5}{8}$ inches.
	Weight	37 lbs.
No. 131 R.	Overall Dimensions	7 $\frac{1}{8}$ × 4 $\frac{1}{8}$ × 4 $\frac{3}{8}$ inches.
	Weight	5 lbs.

It is sometimes convenient to use low resistance Telephones with crystal valve sets, and for this it is necessary to insert a Step-down Transformer. Two types are made. With valves they are always recommended, and No. 130 R has been found to give the highest sensitiveness with musical notes not exceeding 600 per second.

Transformer No. 131 R is recommended for crystals and where the musical note to be received exceeds 600 per second, and also in cases where space is limited.

A Step-down Transformer is not necessary with those crystal receivers where it is already stated that low resistance telephones are to be used, as in those cases a transformer is included in the receiver.

Fleming Valves.

(Patent No. 24850/1904.)



Reference Nos. 132 R.
Code Words: Attingitur.



133 R.
Attiraglid



134 R.
Attistic.



135 R.
Attoken.

No. 132 R	12-volt metallic filament valve	'8 Amps.
No. 133 R	12 ,, carbon ,, ,,	1'6 ,,
No. 134 R	4 ,, carbon ,, ,,	'6 ,,
No. 135 R	4 ,, metallic ,, ,,	'25 ,,

The 4-volt Metallic Filament Valve is supplied with a metal gauze screen to protect it from the transmitted waves. The 4-volt carbon Valve is recommended for all ordinary purposes.

Selected Crystals (Carborundum).

(Patent No. 5332/1907.)

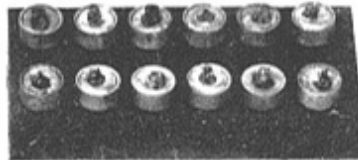

Reference No. 136 R. *Code Word: Adocius.*

Carborundum Crystals are supplied either as picked Crystals set in cups, for receiving purposes, or picked crystals for Wavemeter and Decremeters. These latter Crystals are not set in cups and are not suitable as sensitive detectors in receivers. Set Crystals are usually sent out as shewn in the block, 12 crystals mounted on an ebonite block holder. If they are numbered, a careful check on their peculiarities can be maintained.

Potential Changers.

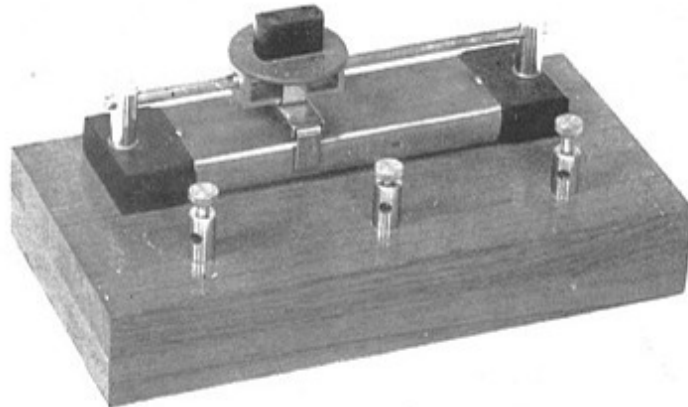

Reference No. 137 R. *Code Word : Ardidelphi.*

Potential Changers and Variable Resistances can be supplied mounted on wood or ebonite. Various resistances and sizes can be supplied.

Crystal Clips.

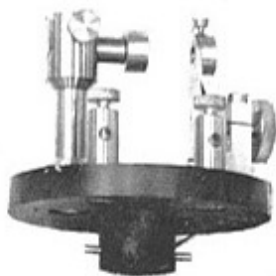

Reference No. 138 R. *Code Word : Adonnoro.*

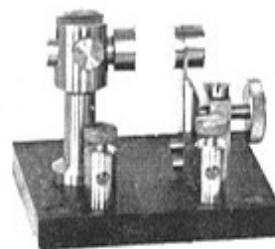

Reference No. 139 R. *Code Word : Adonteremo.*

Special Clips for carborundum crystals with hardened steel contacts can be supplied. No. 138 R is mounted on an adapter to allow of use in place of valves on valve receivers. No. 139 R is mounted on an independent base with terminals.

Charging Switchboards and Battery Boxes.



Reference No. 140 R. *Code Word: Astynirdus.*

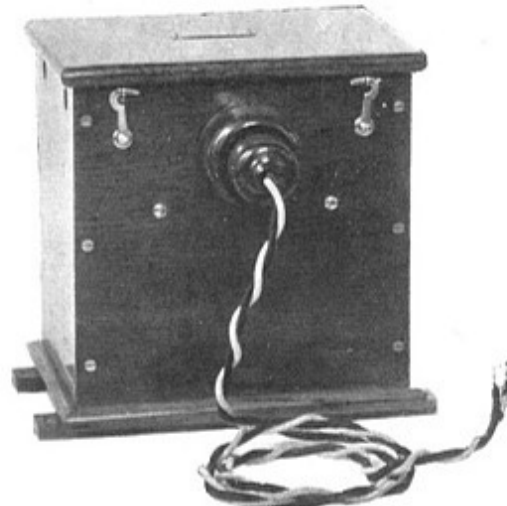

Reference No. 141 R. *Code Word: Abaniquero.*

Small switchboard (140 R) for charging receiver cells on any voltage as in the above block.

Overall Dimensions $9\frac{3}{4} \times 8\frac{1}{2} \times 2\frac{3}{4}$ inches. Weight 6 lbs.

Battery boxes (141 R) supplied for 6-volt accumulators for valve working.

Dimensions $8\frac{3}{8} \times 6\frac{7}{8} \times 9$ inches. Weight (with cell) $19\frac{1}{2}$ lbs.

Other types of switchboard and battery boxes can be provided on request.

Shunted Buzzers.

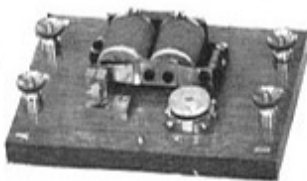

Reference No. 142 R. *Code Word: Accalust.*



Reference No. 143 R. *Code Word: Accalugno.*



No. 142 R is a Shunted Low-note Buzzer giving an irregular spark frequency similar to ordinary spark sets.

No. 143 R is a Shunted High-note Buzzer giving a regular musical frequency variable from 200 to 1,000 per second.